



## K300 DIRECT

Design Pierre Scholtès

### REFERENCE

<b>A122218</b>	2x18w	TCL	2G11	E / B	30x30x5 cm
<b>A122226</b>	2x26w	TCDE	G24q3	E / D	30x30x5 cm

Aluminium + Polycarbonate

**E** : Evg : Ballast électronique - Electronic ballast - Elektronisches Vorschaltgerät.

**D** : Dim 1/10v : Ballast dimmable 1/10v - Dimmable ballast 1/10v .

**B** : Battery : 3 hours battery for security lamp - Notlicht.



## K400 DIRECT

Design Pierre Scholtès

### REFERENCE

<b>A122224</b>	2x24w	TCL	2G11	E / B	40x40x5 cm
<b>A122324</b>	3x24w	TCL	2G11	E / D / P / I / B	40x40x5 cm

Aluminium + Polycarbonate

**E** : Evg : Ballast électronique - Electronical ballast - Elektronisches Vorschaltgerät.



**D** : Dim 1/10v : Ballast dimmable 1/10v - Dimmable ballast 1/10v .

**P** : Pushdim : Ballast dimmable à bouton poussoir - Dimmable ballast Pushdim.

**I** : Dali : Ballast dimmable Dali - Dimmable ballast Dali - Dimbares EVG Dali.

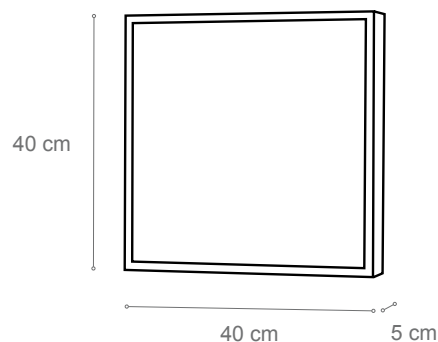
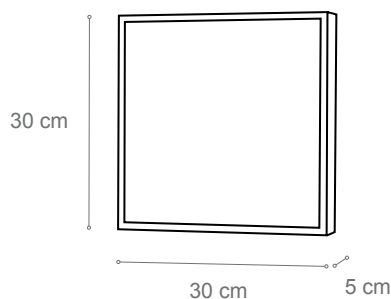
**B** : Battery : 3 hours battery for security lamp - Notlicht.

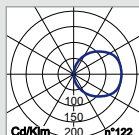

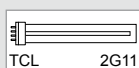

2 x 18w  
2800 lumens

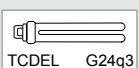

2 x 26w  
3600 lumens

**E**  
Evg

**D**  
Dim  
1 / 10v

**B**  
Battery

**.00**  
alu  
anodise

**.05**  
black  
noir

**.16**  
white  
blanc



**I**

IP  
20

960°





3 Kg





230V  
AC

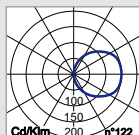

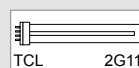

2 x 24w  
3600 lumens

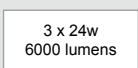

3 x 24w  
6000 lumens

**E**  
Evg

**D**  
Dim  
1 / 10v

**P**  
Pushdim

**I**  
Dali

**B**  
Battery

**.00**  
alu  
anodise

**.05**  
black  
noir

**.16**  
white  
blanc



**I**

IP  
20

960°



4 Kg





230V  
AC

